

Reyem

1984-2024

40 YEARS

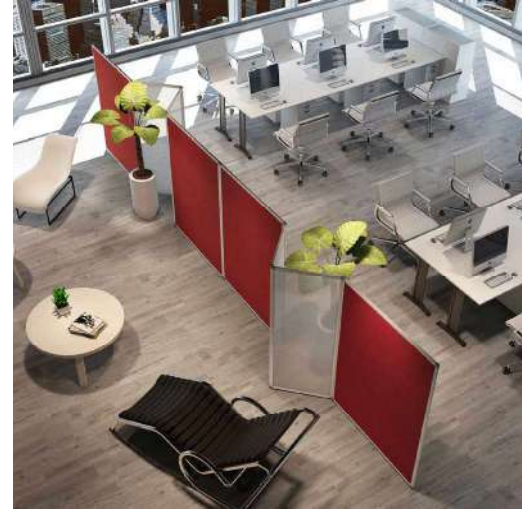

CLOISONNETTES

+SOLUTIONS ACOUSTIQUES



OFFICE SCREENS

+ACOUSTIC SOLUTIONS



STELLWÄNDE

+AKUSTISCHE LÖSUNGEN



Available on



2024



SOMMAIRE

Available on
pCon
PLANNER



TABLE OF CONTENTS

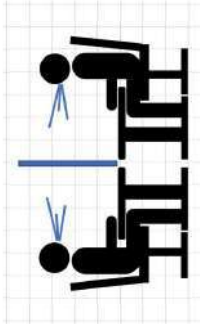

6
Protections COVID-19
&
25
COVID-19 protections
COVID-19 Schutzwände



INHALTSVERZEICHNIS

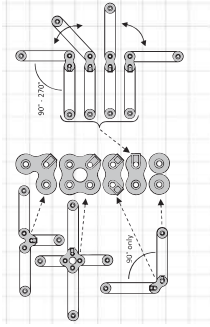

8
Système d'assemblage
Assembly system
Montagesystem



10
Mélaminé
Melamine
Melamin



14
Tissu
Fabric
Stoff



20
Acoustique
Acoustic
Akustik



30
Piétements & roulettes
Feet & castors
Füße & Rollen



34
Postes de travail & Call Center
Workstations & Call center
Arbeitsplätze & Call Center

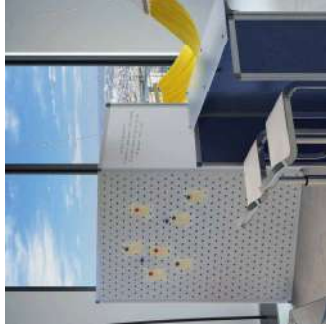

32
Toile perforée magnétique
Magnetic perforated metal sheet
Magnetically Lochblech



38
Réhausse + écran en verre
Glass desk screen + topper
Glaswände + Aufsatz



33
Panneaux pour banque d'accueil
Panels for reception desk
Wände für Empfangstheke



40
Accessoires
Accessories
Zubehör



22
Super-Acoustique
Super-Acoustic
Super-Akustik



24
Verre acrylique + Polycarbonate
Acrylic glass & Polycarbonate
Acrylglas & Polycarbonat



28
Panneaux d'affichage magnétiques
Magnetic notice boards
Magnetically Anschlagtafel



42
Solutions acoustiques
Acoustic solutions
Akustische Lösungen



44
Cloisons mobiles sur roulettes
Freestanding screens on castors
Bewegliche Wände auf Rollen



46
Conditions de transport
Conditions of transport
Beförderungsbedingungen



**PROTECTIONS
COVID-19**



**COVID-19
PROTECTIONS**



**COVID-19
SCHUTZWÄNDE**

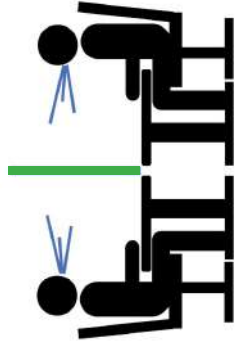

Voir pages 25-27

See pages 25-27

Siehe Seiten 25-27

Verre acrylique incolore 3 ou 4mm
Dimensions standards ou sur mesure

Dimensions maximum conseillées :

Épaisseur 3mm Ref. PX3 : 800 x 800 mm
Épaisseur 4mm Ref. PX4 : 1000x1000mm

Découpe sur mesure, veuillez nous consulter

3 or 4mm colourless acrylic glass
Standard or custom dimensions

Maximum dimensions:

3mm thick Ref. PX3: 800 x 800 mm
4mm thick Ref. PX4: 1000 x 1000mm

Cut to size, please contact us

3 oder 4mm Klaracrylglas
Standard- oder benutzerdefinierte
Abmessungen

Maximale Abmessungen:

3mm dick Ref. PX3: 800 x 800 mm
4mm dick Ref. PX4: 1000 x 1000mm

Zuschnitt nach Maß, kontaktieren Sie uns

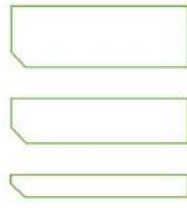

Hauteur
Height
Höhe

390 mm

Ref. PX3 390 x 50
Ref. PX4 390 x 50
Ref. PX3 390 x 100
Ref. PX4 390 x 100
Ref. PX3 390 x 150
Ref. PX4 390 x 150



Hauteur
Height
Höhe

590 mm

Ref. PX3 590 x 190
Ref. PX4 590 x 190
Ref. PX3 590 x 390
Ref. PX4 590 x 390
Ref. PX3 590 x 590
Ref. PX4 590 x 590
Ref. PX3 590 x 790
Ref. PX4 590 x 790

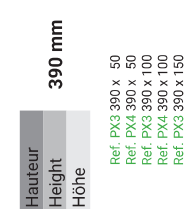

Hauteur
Height
Höhe

590 mm

Ref. PX3 590 x 50
Ref. PX4 590 x 50
Ref. PX3 590 x 100
Ref. PX4 590 x 100
Ref. PX3 590 x 150
Ref. PX4 590 x 150

Ref. PX3 790 x 190
Ref. PX4 790 x 190
Ref. PX3 790 x 390
Ref. PX4 790 x 390
Ref. PX3 790 x 590
Ref. PX4 790 x 590
Ref. PX3 790 x 790
Ref. PX4 790 x 790

Connecteur
pour verre acrylique de 3 ou 4mm



Ref. PLE 202



Connector
for 3 or 4mm acrylic glass



Ref. PLE 203

Verbinde
für 3 oder 4mm Acrylglas



Ref. PLE 222

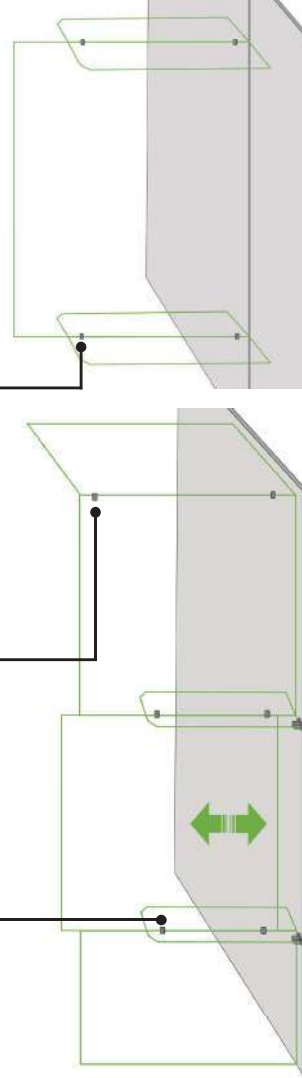

Ref. MVM 280 → 10 - 28mm



Ref. MVM 380 → 20 - 38mm

Pince bureau métallique
+ clip pour verre acrylique de 3 ou 4 mm

Metal desk clamp
+ clip for 3 or 4mm acrylic glass

Tischklammer
+ Klip für 3 oder 4mm Acrylglas



SYSTÈME D'ASSEMBLAGE



ASSEMBLY SYSTEM



MONTAGE-SYSTEM

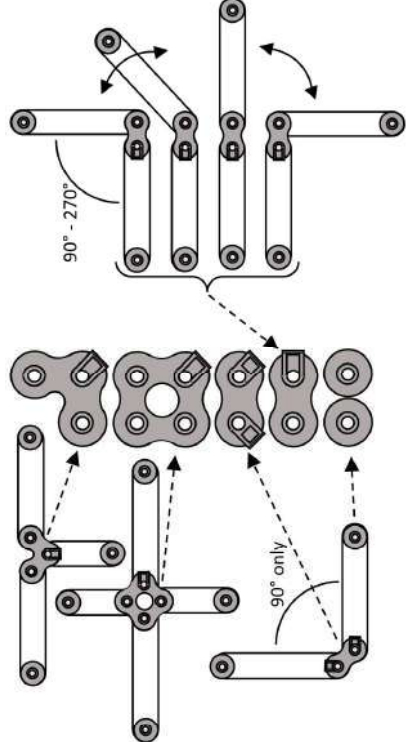
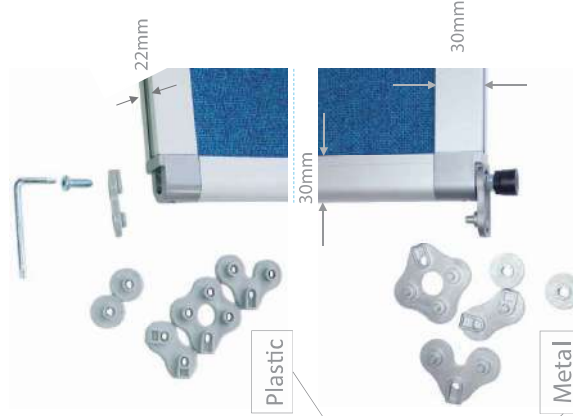
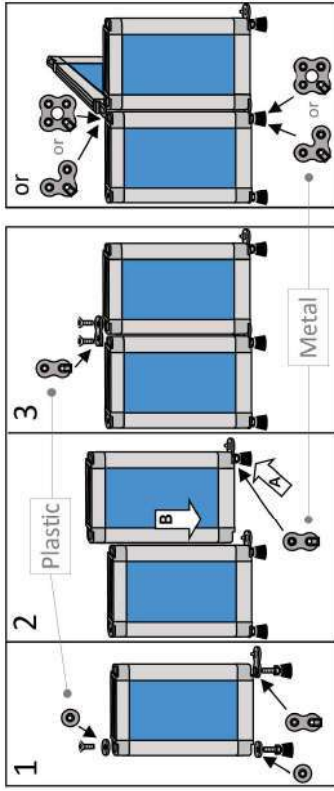

TECHNICAL DATA



TECHNISCHEN DATEN

<p>OSSATURE</p> <p>Toutes les cloisons Reyem sont fabriquées avec une ossature en aluminium anodisé nature de 30mm, d'épaisseur 22mm et assemblées avec des pièces d'angle en alliage de zinc, peinture liquide RAL 9006.</p>	<p>FRAME</p> <p>Each Reyem screen is made using a colourless, anodised aluminium frame of 30mm and 22mm thick. The frame is assembled with corner pieces made of a zinc alloy, liquid paint RAL 9006.</p>	<p>RAHMEN</p> <p>Jede Reyem-Wand wird mit einem 30mm und 22mm dicken Rahmen aus farblosem, eloxiertem Aluminium gefertigt. Der Rahmen wird mit zinklegierten Eckstücken, flüssige Farbe RAL 9006 zusammengesetzt.</p>
<p>MELAMINE</p> <p>Méla miné d'épaisseur 19mm, classement au feu M3 / D, s2, d0. Classement au feu M1 / B, s1, d0 possible, veuillez nous consulter pour prix et délais. Coloris page 11</p>	<p>MELAMINE</p> <p>19mm thick melamine, fire safety classification: D, s2, d0. Fire safety classification B, s2, d0 possible, please contact us for price and delivery time. Colours page 11</p>	<p>MELAMIN</p> <p>19mm Melamin, Feuersicherungs: D, s2, d0. Feuersicherung B, s2, d0 möglich, bitte kontaktieren Sie uns für Preis und Lieferzeit. Melaminfarben Seite 11</p>
<p>TISSU</p> <p>Aggloméré de 16mm 100% PEFC et FSC + Colle à l'eau + Textile (voir page 15) Tests acoustiques page 17</p>	<p>FABRIC</p> <p>16mm thick chipboard 100% PEFC et FSC + Water glue + Textile (see page 15) Acoustic tests page 17</p>	<p>STOFF</p> <p>16mm Spanplatten 100% PEFC- und FSC-zertifiziert + Wasser-Leim + Textil (siehe Seite 15) Akustikteste Seite 17</p>
<p>ACOUSTIQUE</p> <p>Aggloméré de 10mm 100% PEFC et FSC + 2 x 5mm de mousse polyuréthane, densité 23 kg/m3 + Colle à l'eau + Textile (voir page 15) Tests acoustiques page 17</p>	<p>ACOUSTIC</p> <p>10mm thick chipboard 100% PEFC et FSC + 2 x 5mm foam 100% polyurethane, density 23 kg/m3 + Water glue + Textile (see page 15) Acoustic tests page 17</p>	<p>AKUSTIK</p> <p>10mm Spanplatten 100% PEFC- und FSC-zertifiziert + 2 x 5mm Schaum 100% Polyurethan, Dichte 23 kg/m3 + Wasser-Leim + Textil (siehe Seite 15) Akustikteste Seite 17</p>
<p>SUPER-ACOUSTIQUE</p> <p>2 x 5mm de Medium Density Fibreboard (MDF) + 2 x 15mm de fibre 100% polyester, densité 30 kg/m3 + Textile (voir page 15) Tests acoustiques page 17</p>	<p>SUPER-ACOUSTIC</p> <p>2 x 5mm thick Medium Density Fibreboard (MDF) + 2 x 15mm 100% polyester fibre, density 30 kg/m3 + Textile (see page 15) Acoustic tests page 17</p>	<p>SUPER-AKUSTIK</p> <p>2 x 5mm Medium Density Fibreboard (MDF) + 2 x 15mm 100% Polyesterfaser, Dichte 30 kg/m3 + Textil (siehe Seite 15) Akustikteste Seite 17</p>
<p>VERRE ACRYLIQUE</p> <p>Finition verre acrylique 3mm. Incolore, fumé gris, ou opale, résistance durable aux UV, classement feu M4 / E, + Profilé de compensation en PVC noir</p>	<p>ACRYLIC GLASS</p> <p>3mm thick acrylic glass. Colourless, gray tinted or opal, long-lasting UV resistance, fire safety classification: E + compensator profile made of black PVC</p>	<p>ACRYLGLAS</p> <p>3mm Acrylglas, Klar, grau Rauch oder Opal. Langlebig UV-beständig, Feuersicherung: E. + Kompensator Profil schwarz PVC</p>
<p>POLYCARBONATE ALVÉOLAIRE</p> <p>Finition polycarbonate alvéolaire incolore 6mm. Protection UV par coextrusion, classement au feu M1 / B, s1, d0 + Profilé de compensation en PVC</p>	<p>ALVEOLAR POLYCARBONATE</p> <p>6mm thick colourless alveolar polycarbonate. UV protection by coextrusion, fire classification: B, s1, d0 + compensator profile made of black PVC</p>	<p>POLYCARBONAT</p> <p>6mm Klarpolycarbonat, UV-beständig (Coextrusion), Feuersicherung Class B, s1, d0. + Kompensator Profil schwarz PVC</p>
<p>AFFICHAGE MAGNÉTIQUE</p> <p>Face magnétique émaillée blanche (disponible en 1 ou 2 faces)</p>	<p>MAGNETIC NOTICE BOARDS</p> <p>Enameled white magnetic side (available on 1 or 2 sides)</p>	<p>MAGNETISCHE ANSCHLAGTAFELN</p> <p>Emalliert weiß magnetisch Seite (Verfügbar auf 1 oder 2 Seiten)</p>



MÉLAMINÉ



MELAMINE



MELAMIN



Méla miné d'épaisseur 19mm, fibre du bois horizontal (Epaisseur 8mm possible, voir page 45). 100% PEFC et FSC.

19mm thick melamine, wood fiber horizontal (8mm melamine possible, see page 45). 100% PEFC and FSC.

19mm Melamin, Waagerecht Holzfas e (8mm Melamin möglich, siehe Seite 45). 100% PEFC- und FSC-zertifiziert.

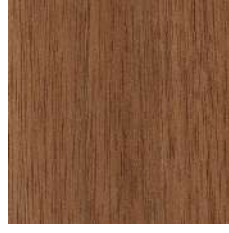

H 3734

Noyer
Walnut wood
Nussbaum

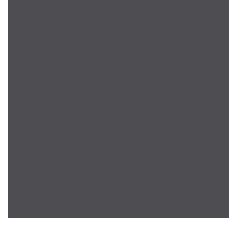

U 963



U 113

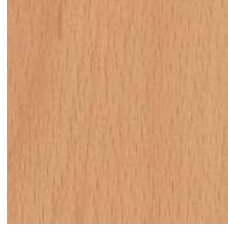

H 1582

Hêtre
Beech
Buche

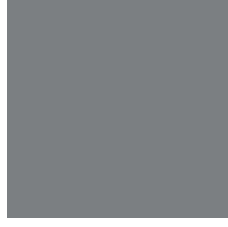

U 732

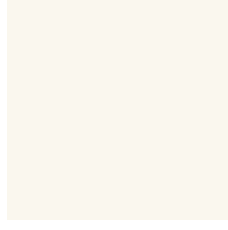

W 908



375 M

Erable
Maple
Ahorn

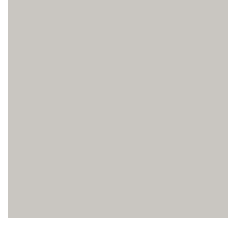

U 708

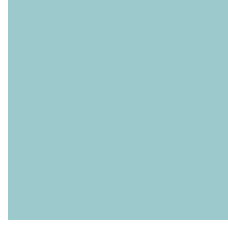

U 500



Pour un classement au feu M1 / B, s2, d0, d'autres mélaminés ou coloris, veuillez nous consulter.

Les photographies des mélaminés sont présentées à titre indicatif. Des variations de couleurs peuvent se produire. Nous vous conseillons de demander de vrais échantillons.

For B, s2, d0 fire safety classification, other melamine or colour finishes, please contact us.

The photographs of the melamine finishes are shown as a guideline only. Colours may vary. We recommend that you ask for samples before ordering.

Bei Fragen bezüglich der Brandschutzklasseneinstufung B, s2, d0, anderen Melaminbeschichtungen oder Farb tön en wenden Sie sich an uns.

Die Abbildungen der Melaminbeschichtungen sind unverbindlich. Es können Farbabweichungen auftreten. Wir empfehlen Ihnen, echte Problemuster anzufordern.



CLOISONNETTE MÉLAMINÉ



MELAMINE SCREEN



MELAMIN- STELLWAND



Kit de montage livré avec chaque cloisonnette

Fitting set supplied with each screen

Ein Bausatz versorgt mit jeder Stellwand

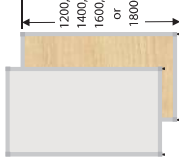

Hauteur
Height
Höhe

Ref. MMM 1200 x 610
Ref. MMM 1200 x 810
Ref. MMM 1200 x 1010
Ref. MMM 1200 x 1210
Ref. MMM 1200 x 1410
Ref. MMM 1200 x 1610

1200 mm

Ref. MMM 1400 x 610
Ref. MMM 1400 x 810
Ref. MMM 1400 x 1010
Ref. MMM 1400 x 1210
Ref. MMM 1400 x 1410
Ref. MMM 1400 x 1610

1400 mm

Ref. MMM 1600 x 610
Ref. MMM 1600 x 810
Ref. MMM 1600 x 1010
Ref. MMM 1600 x 1210
Ref. MMM 1600 x 1410
Ref. MMM 1600 x 1610

1600 mm

Ref. MMM 1800 x 610
Ref. MMM 1800 x 810
Ref. MMM 1800 x 1010
Ref. MMM 1800 x 1210
Ref. MMM 1800 x 1410
Ref. MMM 1800 x 1610

1800 mm

Ref. MMM 1800 x 610
Ref. MMM 1800 x 810
Ref. MMM 1800 x 1010
Ref. MMM 1800 x 1210
Ref. MMM 1800 x 1410
Ref. MMM 1800 x 1610

Avec verre acrylique incolore, fumé gris ou opale de 3mm ou polycarbonate alvéolaire 6mm

With 3mm acrylic glass or 6mm alveolar polycarbonate

Mit 3mm Acrylglas oder 6mm Klarpolycarbonat

Ref. 1200 x 610
Ref. 1200 x 810
Ref. 1200 x 1010
Ref. 1200 x 1210
Ref. 1200 x 1410
Ref. 1200 x 1610

Ref. 1400 x 610
Ref. 1400 x 810
Ref. 1400 x 1010
Ref. 1400 x 1210
Ref. 1400 x 1410
Ref. 1400 x 1610

Ref. 1600 x 610
Ref. 1600 x 810
Ref. 1600 x 1010
Ref. 1600 x 1210
Ref. 1600 x 1410
Ref. 1600 x 1610

Ref. 1800 x 610
Ref. 1800 x 810
Ref. 1800 x 1010
Ref. 1800 x 1210
Ref. 1800 x 1410
Ref. 1800 x 1610



Ref. MMJ

Incolore

Colourless

Klar



Ref. MMG

Fumé gris

Gray tinted

Grau Rauch



Ref. MML

Opale

Opal

Opal



Ref. MMP

Polycarbonate alvéolaire incolore

Classement feu M1 / B, s1, d0

Clear alveolar polycarbonate

Fire safety classification B, s1, d0

Klarpolycarbonat

Feuersicherung Class B, s1, d0



Ref. MVP 300

Pied sur platine plate

Prix unitaire

Foot on flat plate

Unit price

Fuß auf flacher Platte

Stückpreis



Ref. MVP 360

Pied Réglable

Prix unitaire

Adjustable foot

Unit price

Verstellbarer Fuß

Stückpreis



ÉCRAN DE BUREAU MÉLAMINÉ



MELAMINE DESK SCREEN



MELAMIN- TISCH-TRENNWAND



Hauteur
Height
Höhe

Ref. MMB 400 x 800
Ref. MMB 400 x 1000
Ref. MMB 400 x 1200
Ref. MMB 400 x 1400
Ref. MMB 400 x 1600
Ref. MMB 400 x 1800

400 mm

Ref. MMB 600 x 800
Ref. MMB 600 x 1000
Ref. MMB 600 x 1200
Ref. MMB 600 x 1400
Ref. MMB 600 x 1600
Ref. MMB 600 x 1800

600 mm

Ref. MMB 800 x 800
Ref. MMB 800 x 1000
Ref. MMB 800 x 1200
Ref. MMB 800 x 1400
Ref. MMB 800 x 1600
Ref. MMB 800 x 1800

800 mm

Avec verre acrylique incolore, fumé gris ou opale de 3mm ou polycarbonate alvéolaire de 6mm, à préciser à la commande

With 3mm colourless, gray tinted or opal acrylic glass or 6mm alveolar polycarbonate, please specify when ordering

Mit 3mm Klar, grau Rauch oder Opal Acrylglas oder 6mm Klarpolycarbonat, bitte bei Bestellung angeben



Ref. MMA 600 x 800
Ref. MMA 600 x 1000
Ref. MMA 600 x 1200
Ref. MMA 600 x 1400
Ref. MMA 600 x 1600
Ref. MMA 600 x 1800

Ref. MMA 600 x 800
Ref. MMA 600 x 1000
Ref. MMA 600 x 1200
Ref. MMA 600 x 1400
Ref. MMA 600 x 1600
Ref. MMA 600 x 1800

Ref. MMA 600 x 800
Ref. MMA 600 x 1000
Ref. MMA 600 x 1200
Ref. MMA 600 x 1400
Ref. MMA 600 x 1600
Ref. MMA 600 x 1800

Prix unitaire

Stückpreis

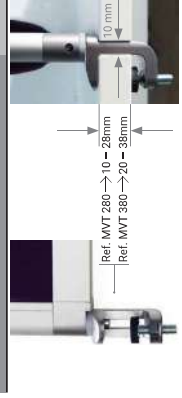

Ref. MVT 280
Ref. MVT 380

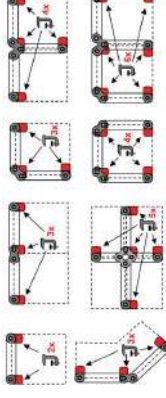

Ref. MVU 280
Ref. MVU 380

Position et quantité de pinces nécessaires selon l'implémentation
Clamps position and number required depending on the layout
Klammern Positionen und Mengen erforderlich je nach Standort.

FIXATION
POUR BUREAUX BENCH
Veillez préciser l'épaisseur
du plateau

FIXING
FOR BENCH DESKS
Bitte geben Sie die Stärke
der Tischplatte an

BEFESTIGUNG FÜR
BENCH SCHREIBTISCHE
Bitte geben Sie die Stärke
der Tischplatte an

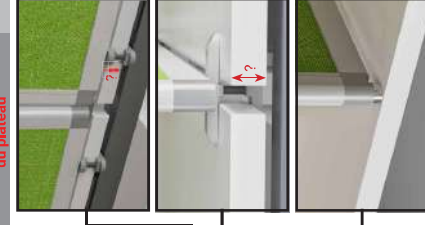

Ref. PBS

Ref. PBD

Ref. CVL

Sabot à poser sur le bureau

Base to place on the desk

Socket auf den Tisch zu legen

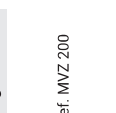

Ref. MVZ 200



TISSU



FABRIC



STOFF



40% laine et 60% viscose

40% wool and 60% viscose

40% Wolle und 60% Viskose



A 204



A 243



A 220



A 228



A 221



A 203

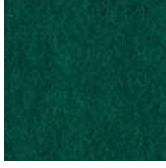

A 244

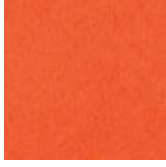

A 232



A 229



A 201



A 230



A 235



A 206



A 231

Moucheté

Speckled

Gesprenkelter



G 365



G 366

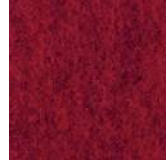

G 369



G 370



G 368

Pour d'autres gammes ou coloris, veuillez nous consulter.

Les photographies des tissus sont présentées à titre indicatif. Des variations de couleurs peuvent se produire. Nous vous conseillons de demander de vrais échantillons.

For other fabric range or colours, please contact us.

The photographs of the fabric finishes are shown as a guideline only. Colours may vary. We recommend that you ask for samples before ordering.

Andere Stoffe oder Farbe, kontaktieren Sie uns.

Die Abbildungen der Stoffbeschichtungen sind unverbindlich. Es können Farbabweichungen auftreten. Wir empfehlen Ihnen, echte Probenmuster anzufordern.





TESTS ACOUSTIQUES



ACOUSTIC TESTS

TISSU



FABRIC

ACOUSTIQUE



ACOUSTIC

SUPER-ACOUSTIQUE



SUPER-ACOUSTIC



AKUSTIKTESTE

STOFF

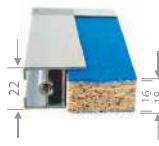

AKUSTIK

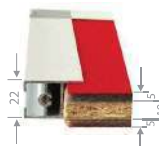

- 2 x 5mm de mousse + tissu
- 2 x 5mm foam + fabric
- 2 x 5mm Schaum + Stoff

SUPER-AKUSTIK



Le coefficient α_s exprime l'absorption de l'énergie sonore par la cloison de 0 à 1 (0 à 100%). Dans les bureaux, les fréquences se situent généralement entre 500 et 4000 Hertz (sons graves ou aigus). Le coefficient α_w exprime l'absorption acoustique pondérée.

The α_s coefficient is used to describe the partition's sound absorption on a scale from 0 to 1 (0 to 100%). In offices, these levels generally remain between 500 and 4000 Hertz (low- or high-pitched sounds). The α_w coefficient describes the weighted acoustic absorption.

Der Koeffizient α_s gibt die von der Trennwand absorbierte Schallenergie von 0 bis 1 (0 bis 100%) an. In Büros liegen die Frequenzen in der Regel zwischen 500 und 4000 Hertz (tiefe oder hohe Töne). Der Koeffizient α_w gibt den gewichteten Schallabsorptionsgrad an.

	Mélanimé Melamine	Tissu Fabric	Acoustique Acoustic	Super-Acoustique Super-Acoustic
α_w	0,05(I)	0,10	0,15(H)	0,45(H)

Frequency (Hz)	0,00	0,00	0,00	0,00	0,13
100	0,00	0,00	0,00	0,00	0,13
125	0,00	0,01	0,00	0,00	0,19
160	0,00	0,02	0,00	0,04	0,22
200	0,00	0,00	0,00	0,04	0,26
250	0,03	0,05	0,07	0,05	0,30
315	0,02	0,04	0,05	0,04	0,28
400	0,02	0,03	0,04	0,04	0,32
500	0,01	0,02	0,05	0,05	0,36
630	0,02	0,04	0,08	0,08	0,41
800	0,03	0,04	0,12	0,12	0,45
1000	0,03	0,05	0,14	0,14	0,52
1250	0,04	0,08	0,16	0,16	0,60
1600	0,03	0,09	0,21	0,21	0,70
2000	0,04	0,08	0,24	0,24	0,79
2500	0,05	0,10	0,31	0,31	0,87
3150	0,04	0,09	0,38	0,38	0,91
4000	0,08	0,11	0,44	0,44	0,94
5000	0,20	0,21	0,53	0,53	0,96

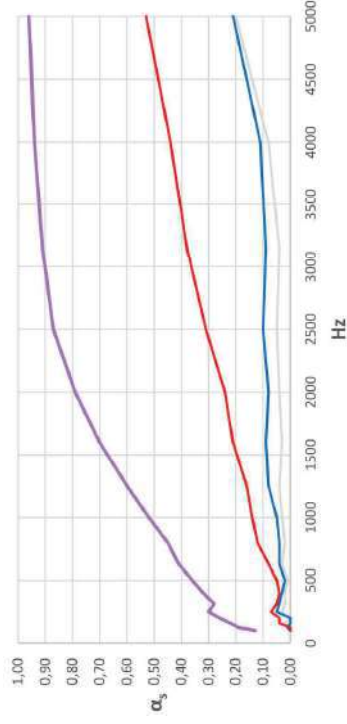
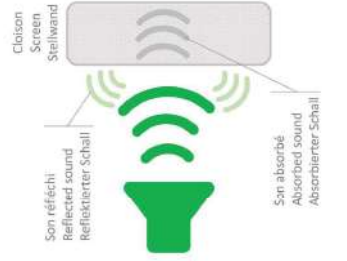



CLOISONNETTE SUPER-ACOUSTIQUE



SUPER-ACOUSTIC SCREEN



SUPER AKUSTIK- STELLWAND



Kit de montage livré avec chaque cloisonnette

Fitting set supplied with each screen

Ein Bausatz versorgt mit jeder Stellwand

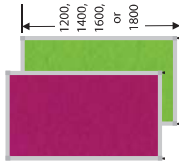

Hauteur Height Höhe	1200 mm	1400 mm	1600 mm	1800 mm
	Ref. ATT 1200 x 610	Ref. ATT 1400 x 610	Ref. ATT 1600 x 610	Ref. ATT 1800 x 610
	Ref. ATT 1200 x 810	Ref. ATT 1400 x 810	Ref. ATT 1600 x 810	Ref. ATT 1800 x 810
	Ref. ATT 1200 x 1010	Ref. ATT 1400 x 1010	Ref. ATT 1600 x 1010	Ref. ATT 1800 x 1010
	Ref. ATT 1200 x 1210	Ref. ATT 1400 x 1210	Ref. ATT 1600 x 1210	Ref. ATT 1800 x 1210
	Ref. ATT 1200 x 1410	Ref. ATT 1400 x 1410	Ref. ATT 1600 x 1410	Ref. ATT 1800 x 1410
	Ref. ATT 1200 x 1610	Ref. ATT 1400 x 1610	Ref. ATT 1600 x 1610	Ref. ATT 1800 x 1610

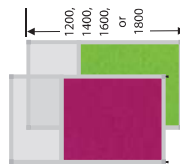

Avec verre acrylique incolore, fumé gris ou opale de 3mm ou polycarbonate alvéolaire de 6mm, à préciser à la commande
With 3mm colourless, gray tinted or opal acrylic glass or 6mm alveolar polycarbonate, please specify when ordering
Mit 3mm Klar, grau Rauch oder Opal Acrylglas oder 6mm Klarpolycarbonat, bitte bei Bestellung angeben

Ref.	1200 x 610	1400 x 610	1600 x 610	1800 x 610
Ref.	1200 x 810	1400 x 810	1600 x 810	1800 x 810
Ref.	1200 x 1010	1400 x 1010	1600 x 1010	1800 x 1010
Ref.	1200 x 1210	1400 x 1210	1600 x 1210	1800 x 1210
Ref.	1200 x 1410	1400 x 1410	1600 x 1410	1800 x 1410
Ref.	1200 x 1610	1400 x 1610	1600 x 1610	1800 x 1610



Incolore	Ref. ATJ
Colourless	Ref. ATG
Klar	Ref. ATL

Fumé gris	Ref. ATG
Gray tinted	Ref. ATG
Grau Rauch	Ref. ATG

Opale	Ref. ATL
Opal	Ref. ATL
Opal	Ref. ATL

Polycarbonate alvéolaire incolore Classement feu M1 / B, s1, d0	Ref. ATP
Clear alveolar polycarbonate Fire safety classification B, s1, d0	Ref. ATP
Klarpolycarbonat Feuersicherung Class B, s1, d0	Ref. ATP



Ref. MVP 360
Pied réglable Prix unitaire
Adjustable foot Unit price
Verstellbarer Fuß Stückpreis

Ref. MVP 300
Pied sur platine plate Prix unitaire
Foot on flat plate Unit price
Fuß auf flacher Platte Stückpreis



ÉCRAN DE BUREAU SUPER-ACOUSTIQUE



SUPER-ACOUSTIC DESK SCREEN



SUPER AKUSTIK- TISCH-TRENNWAND

Hauteur Height Höhe	400 mm	600 mm	800 mm
---------------------------	--------	--------	--------



Ref. ATB 400 x 800	Ref. ATB 600 x 800
Ref. ATB 400 x 1000	Ref. ATB 600 x 1000
Ref. ATB 400 x 1200	Ref. ATB 600 x 1200
Ref. ATB 400 x 1400	Ref. ATB 600 x 1400
Ref. ATB 400 x 1600	Ref. ATB 600 x 1600
Ref. ATB 400 x 1800	Ref. ATB 600 x 1800

Avec verre acrylique incolore, fumé gris ou opale de 3mm ou polycarbonate alvéolaire de 6mm, à préciser à la commande
With 3mm colourless, gray tinted or opal acrylic glass or 6mm alveolar polycarbonate, please specify when ordering
Mit 3mm Klar, grau Rauch oder Opal Acrylglas oder 6mm Klarpolycarbonat, bitte bei Bestellung angeben



Ref. ATA 600 x 800	Ref. ATA 800 x 800
Ref. ATA 600 x 1000	Ref. ATA 800 x 1000
Ref. ATA 600 x 1200	Ref. ATA 800 x 1200
Ref. ATA 600 x 1400	Ref. ATA 800 x 1400
Ref. ATA 600 x 1600	Ref. ATA 800 x 1600
Ref. ATA 600 x 1800	Ref. ATA 800 x 1800

Prix unitaire	Unit price	Stückpreis
---------------	------------	------------

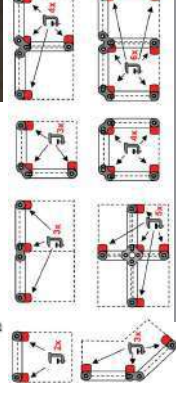
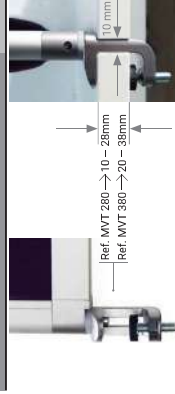

Position et quantité de pièces nécessaires selon l'implantation
Clamps position and number required depending on the layout
Klammern Positionen und Mengen erforderlich je nach Standort.

FIXATION
POUR BUREAUX BENCH
Vous/lezz préciser / epaisseur
du plateau

FIXING
FOR BENCH DESKS
Please specify the thickness
of the desk surface

BEFESTIGUNG FÜR
BENCH SCHREIBTISCHE
Bitte geben Sie die Stärke
der Tischplatte an

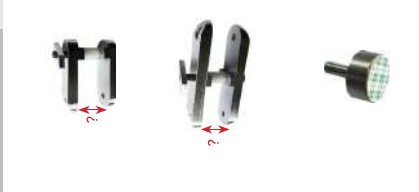
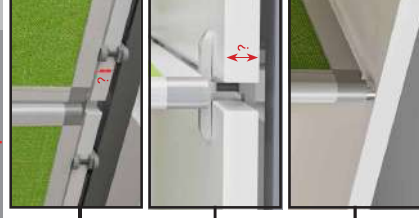
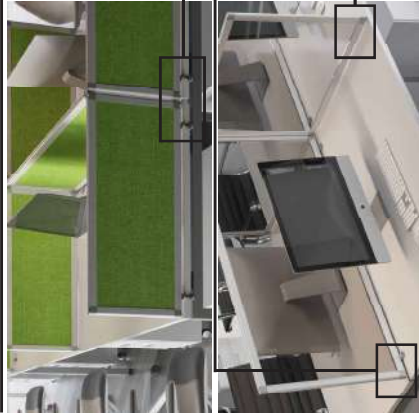

Ref. PBS

Ref. PBD

Ref. CYL

Sabot à poser sur le bureau

Base to place on the desk

Sockel auf den Tisch zu legen

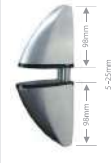

Ref. MVZ 200



**VERRE ACRYLIQUE
+ POLYCARBONATE**



**ACRYLIC GLASS +
POLYCARBONATE**



**ACRYLGLAS +
POLYCARBONAT**



Store
pour cloisonnettes en verre acrylique

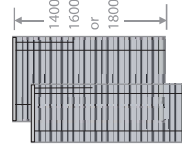

Hauteur
Height
Höhe

Ref. MVV 1400 x 610
Ref. MVV 1400 x 810
Ref. MVV 1400 x 1010
Ref. MVV 1400 x 1210

Venetian blind
for acrylic glass screens

1400 mm

Ref. MVV 1600 x 610
Ref. MVV 1600 x 810
Ref. MVV 1600 x 1010
Ref. MVV 1600 x 1210

Jalousie
für Acrylglas Stellwände

1600 mm

Ref. MVV 1800 x 610
Ref. MVV 1800 x 810
Ref. MVV 1800 x 1010
Ref. MVV 1800 x 1210



CLOISONNETTE VERRE ACRYLIQUE + POLYCARBONATE



ACRYLIC GLASS + POLYCARBONATE SCREEN



ACRYLGLAS + POLYCARBONAT STELLWAND



Kit de montage livré avec chaque cloisonnette
Fitting set supplied with each screen
Ein Bausatz versorgt mit jeder Stellwand

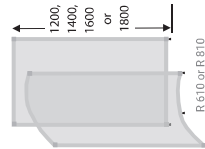

Hauteur
Height
Höhe

1200, 1400, 1600
or
1800

R 610 or R 810

1200 mm

Ref. [MVA 1200 x 610](#)
Ref. [MVA 1200 x 810](#)
Ref. [MVA 1200 x 1010](#)
Ref. [MVA 1200 x 1210](#)

Ref. [MVA 1200 x R610](#)
Ref. [MVA 1200 x R810](#)

1400 mm

Ref. [MVA 1400 x 610](#)
Ref. [MVA 1400 x 810](#)
Ref. [MVA 1400 x 1010](#)
Ref. [MVA 1400 x 1210](#)

Ref. [MVA 1400 x R610](#)
Ref. [MVA 1400 x R810](#)

1600 mm

Ref. [MVA 1600 x 610](#)
Ref. [MVA 1600 x 810](#)
Ref. [MVA 1600 x 1010](#)
Ref. [MVA 1600 x 1210](#)

Ref. [MVA 1600 x R610](#)
Ref. [MVA 1600 x R810](#)

1800 mm

Ref. [MVA 1800 x 610](#)
Ref. [MVA 1800 x 810](#)
Ref. [MVA 1800 x 1010](#)
Ref. [MVA 1800 x 1210](#)

Ref. [MVA 1800 x R610](#)
Ref. [MVA 1800 x R810](#)



Ref. MAJ

Incolore
Colourless

Klar



Ref. MAG

Fumé gris
Gray tinted

Grau Rauch



Ref. MAL

Opale

Opal

Opal

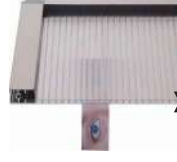

Polycarbonate alvéolaire incolore
Classement feu M1 / B, s1, d0

Clear alveolar polycarbonate
Fire safety classification B, s1, d0

Klarpolycarbonat
Feuersicherung Class B, s1, d0



ÉCRAN DE BUREAU VERRE ACRYLIQUE + POLYCARBONATE



ACRYLIC GLASS + POLYCARBONATE DESK SCREEN



ACRYLGLAS + POLYCARBONAT TISCH-TRENNWAND

Avec verre acrylique incolore, fumé gris ou opale de 3mm ou polycarbonate alvéolaire de 6mm, à préciser à la commande
With 3mm colourless, gray tinted or opal acrylic glass or 6mm alveolar polycarbonate, please specify when ordering
Mit 3mm Klar, grau Rauch oder Opal Acrylglas oder 6mm Klarpolycarbonat, bitte bei Bestellung angeben

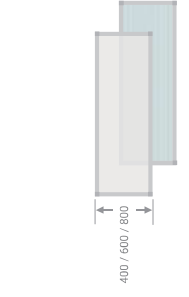

Hauteur
Height
Höhe

400 / 600 / 800

400 mm

Ref. [MVA 400 x 800](#)
Ref. [MVA 400 x 1000](#)
Ref. [MVA 400 x 1200](#)
Ref. [MVA 400 x 1400](#)
Ref. [MVA 400 x 1600](#)
Ref. [MVA 400 x 1800](#)

600 mm

Ref. [MVA 600 x 800](#)
Ref. [MVA 600 x 1000](#)
Ref. [MVA 600 x 1200](#)
Ref. [MVA 600 x 1400](#)
Ref. [MVA 600 x 1600](#)
Ref. [MVA 600 x 1800](#)

800 mm

Ref. [MVA 800 x 800](#)
Ref. [MVA 800 x 1000](#)
Ref. [MVA 800 x 1200](#)
Ref. [MVA 800 x 1400](#)
Ref. [MVA 800 x 1600](#)
Ref. [MVA 800 x 1800](#)

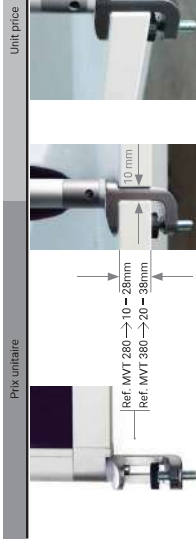

Prix unitaire

Stückpreis



Position et quantité de pinces nécessaires selon l'implantation
Clamps position and number required depending on the layout
Klammern Positionen und Mengen erforderlich je nach Standort.

FIXATION
POUR BUREAUX BENCH
du plateau

BEFESTIGUNG FÜR
BENCH SCHREIBTISCHE
Bitte geben Sie die Stärke
der Tischplatte an

Ref. MVY 280
Ref. MVY 380



Ref. PVS

Ref. PBD

Ref. CYL



CLOISONNETTE VERRE ACRYLIQUE + POLYCARBONATE



ACRYLIC GLASS + POLYCARBONATE SCREEN



ACRYLGLAS + POLYCARBONAT STELLWAND



Kit de montage livré avec chaque cloisonnette
Fitting set supplied with each screen
Ein Bausatz versorgt mit jeder Stellwand

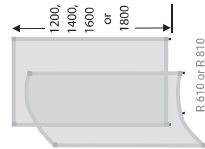

Hauteur
Height
Höhe

1200, 1400, 1600
or
1800

R 610 or R 810

1200 mm

Ref. [MVA 1200 x 610](#)
Ref. [MVA 1200 x 810](#)
Ref. [MVA 1200 x 1010](#)
Ref. [MVA 1200 x 1210](#)

Ref. [MVA 1200 x R610](#)
Ref. [MVA 1200 x R810](#)

1400 mm

Ref. [MVA 1400 x 610](#)
Ref. [MVA 1400 x 810](#)
Ref. [MVA 1400 x 1010](#)
Ref. [MVA 1400 x 1210](#)

Ref. [MVA 1400 x R610](#)
Ref. [MVA 1400 x R810](#)

1600 mm

Ref. [MVA 1600 x 610](#)
Ref. [MVA 1600 x 810](#)
Ref. [MVA 1600 x 1010](#)
Ref. [MVA 1600 x 1210](#)

Ref. [MVA 1600 x R610](#)
Ref. [MVA 1600 x R810](#)

1800 mm

Ref. [MVA 1800 x 610](#)
Ref. [MVA 1800 x 810](#)
Ref. [MVA 1800 x 1010](#)
Ref. [MVA 1800 x 1210](#)

Ref. [MVA 1800 x R610](#)
Ref. [MVA 1800 x R810](#)



Ref. MAJ

Incolore
Colourless

Klar



Ref. MAG

Fumé gris
Gray tinted

Grau Rauch



Ref. MAL

Opale

Opal

Opal



Polycarbonate alvéolaire incolore
Classement feu M1 / B, s1, d0

Clear alveolar polycarbonate
Fire safety classification B, s1, d0

Klarpolycarbonat
Feuersicherung Class B, s1, d0

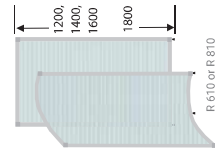

Avec polycarbonate alvéolaire 6mm
With 6mm alveolar polycarbonate
Mit 6mm Klarpolycarbonat

Ref. [MAP 1200 x 610](#)
Ref. [MAP 1200 x 810](#)
Ref. [MAP 1200 x 1010](#)
Ref. [MAP 1200 x 1210](#)
Ref. [MAP 1200 x 1410](#)
Ref. [MAP 1200 x 1610](#)

Ref. [MAP 1200 x R810](#)

Ref. [MAP 1400 x 610](#)
Ref. [MAP 1400 x 810](#)
Ref. [MAP 1400 x 1010](#)
Ref. [MAP 1400 x 1210](#)
Ref. [MAP 1400 x 1410](#)
Ref. [MAP 1400 x 1610](#)

Ref. [MAP 1400 x R810](#)

Ref. [MAP 1600 x 610](#)
Ref. [MAP 1600 x 810](#)
Ref. [MAP 1600 x 1010](#)
Ref. [MAP 1600 x 1210](#)
Ref. [MAP 1600 x 1410](#)
Ref. [MAP 1600 x 1610](#)

Ref. [MAP 1600 x R810](#)



Ref. MVP 300

Pied sur platine plate
Prix unitaire
Foot on flat plate
Unit price
Fuß auf flacher Platte
Stückpreis



Ref. MVP 360

Pied Réglable
Prix unitaire
Adjustable foot
Unit price
Verstellbarer Fuß
Stückpreis

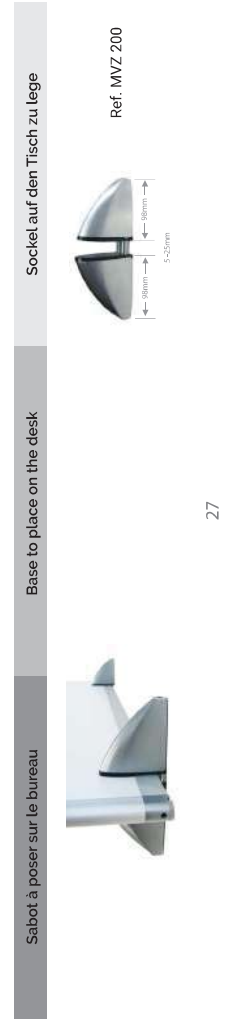

Sabot à poser sur le bureau

Base to place on the desk

Ref. MVZ 200



PANNEAUX D'AFFICHAGE MAGNÉTIQUES



MAGNETIC NOTICE BOARDS



MAGNETISCHE ANSCHLAGTAFELN



Kit de montage livré avec chaque tableau

Fitting set supplied with each screen

Ein Bausatz versorgt mit jeder Stellwand

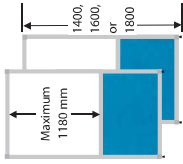
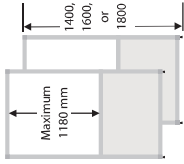
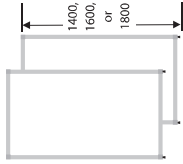
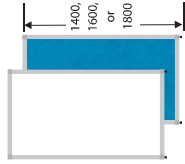
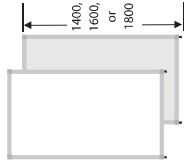

ÉCRAN DE BUREAU MAGNÉTIQUE



MAGNETIC DESK SCREEN



MAGNETISCH TISCH-TRENNWAND

Hauteur
Height
Höhe

400 mm



Ref. TPB 400 x 800
Ref. TPB 400 x 1000
Ref. TPB 400 x 1200
Ref. TPB 400 x 1400
Ref. TPB 400 x 1600
Ref. TPB 400 x 1800

600 mm

Ref. TPB 600 x 800
Ref. TPB 600 x 1000
Ref. TPB 600 x 1200
Ref. TPB 600 x 1400
Ref. TPB 600 x 1600
Ref. TPB 600 x 1800

800 mm

Ref. TPB 800 x 800
Ref. TPB 800 x 1000
Ref. TPB 800 x 1200
Ref. TPB 800 x 1400
Ref. TPB 800 x 1600
Ref. TPB 800 x 1800

Avec verre acrylique incolore, fumé gris ou opale de 3mm ou polycarbonate alvéolaire de 6mm, à préciser à la commande

With 3mm colourless, gray tinted or opal acrylic glass or 6mm alveolar polycarbonate, please specify when ordering

Mit 3mm Klar, grau Rauch oder Opal Acrylglas oder 6mm Klarpolycarbonat, bitte bei Bestellung angeben



Ref. TPA 600 x 800
Ref. TPA 600 x 1000
Ref. TPA 600 x 1200
Ref. TPA 600 x 1400
Ref. TPA 600 x 1600
Ref. TPA 600 x 1800

Ref. TPA 800 x 800
Ref. TPA 800 x 1000
Ref. TPA 800 x 1200
Ref. TPA 800 x 1400
Ref. TPA 800 x 1600
Ref. TPA 800 x 1800



Fixations page 27

Befestigungen Seite 27



MAGNETIC NOTICE BOARDS



MAGNETISCHE ANSCHLAGTAFELN

Hauteur Height Höhe	1400 mm	1600 mm	1800 mm
	1 face magnétique émaillée + 1 face mélaminé blanc 1 enamelled magnetic side + 1 side white melamine 1 emailiert magnetisch Seite + 1 weiße melaminierte Seite		

Ref. TMM 1400 x 610
Ref. TMM 1400 x 810
Ref. TMM 1400 x 1010
Ref. TMM 1400 x 1210

Ref. TMM 1600 x 610
Ref. TMM 1600 x 810
Ref. TMM 1600 x 1010
Ref. TMM 1600 x 1210

Ref. TMM 1800 x 610
Ref. TMM 1800 x 810
Ref. TMM 1800 x 1010
Ref. TMM 1800 x 1210

Hauteur Height Höhe	1400 mm	1600 mm	1800 mm
	1 face magnétique émaillée + 1 face tissu 1 enamelled magnetic side + 1 side fabric 1 emailiert magnetisch Seite + 1 Seite Stoff		

Ref. TTT 1400 x 610
Ref. TTT 1400 x 810
Ref. TTT 1400 x 1010
Ref. TTT 1400 x 1210

Ref. TTT 1600 x 610
Ref. TTT 1600 x 810
Ref. TTT 1600 x 1010
Ref. TTT 1600 x 1210

Ref. TTT 1800 x 610
Ref. TTT 1800 x 810
Ref. TTT 1800 x 1010
Ref. TTT 1800 x 1210

Hauteur Height Höhe	1400 mm	1600 mm	1800 mm
	2 faces magnétiques émaillées 2 enamelled magnetic sides 2 emailiert magnetisch Seiten		

Ref. TEX 1400 x 610
Ref. TEX 1400 x 810
Ref. TEX 1400 x 1010
Ref. TEX 1400 x 1210

Ref. TEX 1600 x 610
Ref. TEX 1600 x 810
Ref. TEX 1600 x 1010
Ref. TEX 1600 x 1210

Ref. TEX 1800 x 610
Ref. TEX 1800 x 810
Ref. TEX 1800 x 1010
Ref. TEX 1800 x 1210

Hauteur Height Höhe	1400 mm	1600 mm	1800 mm
	2 faces magnétiques émaillées + Melaminé 2 enamelled magnetic sides + Melamine 2 emailiert magnetisch Seiten + Melamin		

Ref. TMX 1400 x 610
Ref. TMX 1400 x 810
Ref. TMX 1400 x 1010
Ref. TMX 1400 x 1210
Ref. TMX 1400 x 1410
Ref. TMX 1400 x 1610

Ref. TMX 1600 x 610
Ref. TMX 1600 x 810
Ref. TMX 1600 x 1010
Ref. TMX 1600 x 1210
Ref. TMX 1600 x 1410
Ref. TMX 1600 x 1610

Ref. TMX 1800 x 610
Ref. TMX 1800 x 810
Ref. TMX 1800 x 1010
Ref. TMX 1800 x 1210
Ref. TMX 1800 x 1410
Ref. TMX 1800 x 1610

Hauteur Height Höhe	1400 mm	1600 mm	1800 mm
	2 faces magnétiques émaillées + Tissu 2 enamelled magnetic sides + Fabric 2 emailiert magnetisch Seiten + Stoff		

Ref. TTX 1400 x 610
Ref. TTX 1400 x 810
Ref. TTX 1400 x 1010
Ref. TTX 1400 x 1210
Ref. TTX 1400 x 1410
Ref. TTX 1400 x 1610

Ref. TTX 1600 x 610
Ref. TTX 1600 x 810
Ref. TTX 1600 x 1010
Ref. TTX 1600 x 1210
Ref. TTX 1600 x 1410
Ref. TTX 1600 x 1610

Ref. TTX 1800 x 610
Ref. TTX 1800 x 810
Ref. TTX 1800 x 1010
Ref. TTX 1800 x 1210
Ref. TTX 1800 x 1410
Ref. TTX 1800 x 1610



PIETEMENTS + ROULETTES

Nombre de pieds suivant l'implantation :



FEET + CASTORS

Number of feet required depends on the layout:



FÜßE + ROLLEN

Zahl der Füße kommt darauf das Layout an:

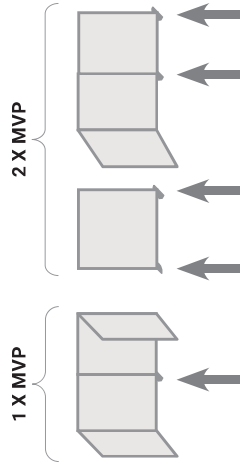

Pas de pied nécessaire pour ces implantations :

No feet required for these layouts:

Für diese Layouts sind keine Füße erforderlich:

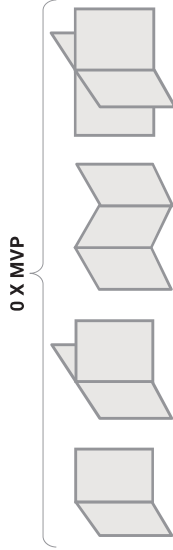

Pied sur platine plate
Prix unitaire



Foot on flat plate
Unit price



Ref. MVP 300

Fuß auf flacher Platte
Stückpreis

Pied réglable
Prix unitaire



Adjustable foot
Unit price



Ref. MVP 360

Verstellbarer Fuß
Stückpreis

Kit complet 4 roulettes avec freins + 2 barres
(pour hauteur maxi 1800mm)



4 locking castor full set + 2 bars
(for maximum height 1800mm)



Ref. MVX 380

Komplettsatz mit 4 Rollen mit Bremsfunktion
(für maxi Höhe 1800mm)



TOLE PERFORÉE MAGNÉTIQUE



MAGNETIC PERFORATED METAL SHEET



MAGNETISCH LOCHBLECH



PANNEAUX POUR BANQUE D'ACCUEIL



PANELS FOR RECEPTION DESK



WÄNDE FÜR EMPFANGSTHEKE



Kit de montage livré avec chaque cloisonnette
Fitting set supplied with each screen
Ein Bausatzt versorgt mit jeder Stellwand

Hauteur
Height
Höhe

1200 mm

1400 mm

1600 mm

1800 mm

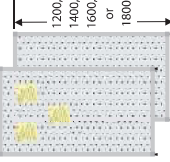

Tôle perforée magnétique acier laqué RAL 9006
RAL 9006 lacquered magnetic perforated metal sheet
Lackierten magnetisch Lochblech RAL 9006

Ref. MPP 1200 x 610
Ref. MPP 1400 x 810
Ref. MPP 1200 x 1010

Ref. MPP 1400 x 610
Ref. MPP 1600 x 810
Ref. MPP 1400 x 1010

Ref. MPP 1600 x 610
Ref. MPP 1800 x 810
Ref. MPP 1600 x 1010

Ref. MPP 1800 x 610
Ref. MPP 1800 x 810
Ref. MPP 1800 x 1010

Tôle perforée magnétique acier laqué RAL 9006 + Melaminé
RAL 9006 lacquered magnetic perforated metal sheet + Melamine
Lackierten magnetisch Lochblech RAL 9006 + Melamin

Ref. MPM 1400 x 610
Ref. MPM 1400 x 810
Ref. MPM 1400 x 1010

Ref. MPM 1400 x 610
Ref. MPM 1600 x 810
Ref. MPM 1400 x 1010

Ref. MPM 1600 x 610
Ref. MPM 1800 x 810
Ref. MPM 1600 x 1010

Ref. MPM 1800 x 610
Ref. MPM 1800 x 810
Ref. MPM 1800 x 1010

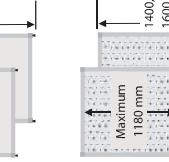

Tôle perforée magnétique acier laqué RAL 9006 + Tissu
RAL 9006 lacquered magnetic perforated metal sheet + Fabric
Lackierten magnetisch Lochblech RAL 9006 + Stoff

Ref. MPT 1400 x 610
Ref. MPT 1400 x 810
Ref. MPT 1400 x 1010

Ref. MPT 1400 x 610
Ref. MPT 1600 x 810
Ref. MPT 1400 x 1010

Ref. MPT 1600 x 610
Ref. MPT 1800 x 810
Ref. MPT 1600 x 1010

Ref. MPT 1800 x 610
Ref. MPT 1800 x 810
Ref. MPT 1800 x 1010

Melaminé 19mm
19mm melamine
19mm Melamin

Hauteur
Height
Höhe

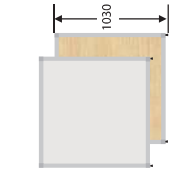

1030 mm

Ref. MMM 1030 x 800
Ref. MMM 1030 x 825
Ref. MMM 1030 x 1000
Ref. MMM 1030 x 1200
Ref. MMM 1030 x 1400
Ref. MMM 1030 x 1600

Tissu
Fabric
Stoff

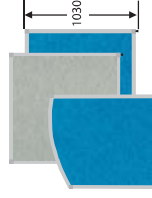

Ref. MTT 1030 x 800
Ref. MTT 1030 x 825
Ref. MTT 1030 x 1000
Ref. MTT 1030 x 1200
Ref. MTT 1030 x 1400
Ref. MTT 1030 x 1600

Tôle perforée acier laqué RAL 9006
RAL 9006 lacquered perforated metal sheet
Lackierten Lochblech RAL 9006



Ref. MPP 1030 x 800
Ref. MPP 1030 x 825
Ref. MPP 1030 x 1000
Ref. MPP 1030 x 1200
Ref. MPP 1030 x 1400
Ref. MPP 1030 x 1600

Tablette en verre Securit dépoli 8mm avec supports MCT 230

8mm frosted Securit glass slab with holders MCT 230

Glasplatte, 8mm Securit Mattglas mit Stützer MCT 230

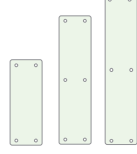

Ref. MCW 300 x 800
Ref. MCW 300 x 1000
Ref. MCW 300 x 1200
Ref. MCW 300 x 1400
Ref. MCW 300 x 1600

Support pour tablette bois ou verre
Holder for glass or wooden slab
Stütze für Holz oder Glasplatte



Ref. MCT 230





POSTES DE TRAVAIL



WORKSTATIONS



ARBEITSPLÄTZE

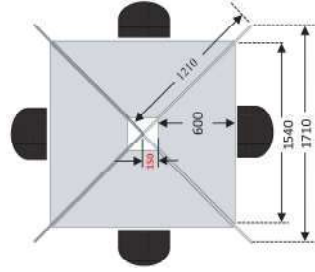
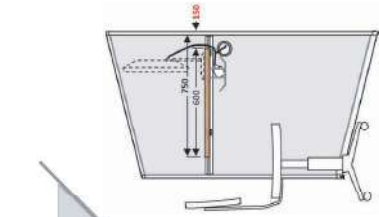
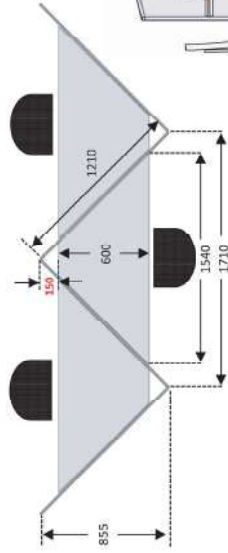

Rail aluminium pour fixation plateau
ou accessoires (voir page 40).
A intégrer dans la cloison.

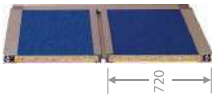

4 Supports pour plateau



Plateau mélaminé blanc ou gris
28mm + 4 supports MVH 110



Aluminum profile for desk surfaces
or accessories (see page 40).
To be integrated into the screen.



4 Holders for desk surfaces



28mm thick white or grey
desk surface + 4 holders MVH 110

Alu-Profil für Tischplatten-Befestigung
oder Zubehör (siehe Seite 40).
In die Wand einlassen.

Ref. MVH 100/ 610
Ref. MVH 100/ 810
Ref. MVH 100/ 1010
Ref. MVH 100/ 1210
Ref. MVH 100/ 1410
Ref. MVH 100/ 1610
Ref. MVH 100/ 1810

4 Halter für Tischplatte

Ref. MVH 110

28mm Melamin Tischplatte weiss
oder grau + 4 Halterungen MVH 110

Ref. MVH 600 x TRAP

Kompakte Typ E Schreibstischsteckdose
mit USB-Ladefunktion 5V / 2,4A



Ref. MVH 213

E type compact desk power plug
with 5V / 2,4A USB charger



Prise compact type E
avec chargeur USB 5V / 2,4A

Kabelwanne 420mm lang under
Tischplatte zu befestigen

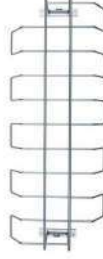

Ref. MVH 212

Cable support 420mm long to fix
under the desk surface



Goulotte pour câbles longueurs
420mm à fixer sous le plateau

Kabelinduführung
(Bei Bestellung angeben)

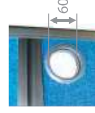

Cable pathway
(to be specified when ordered)

Passage pour câbles
(à prévoir à la commande)

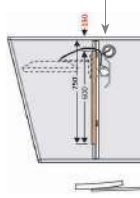

Ref. MVF 111



**POSTES DE TRAVAIL
+ CALL CENTER**



**WORKSTATIONS
+ CALL CENTER**



**ARBEITSPLÄTZE
+ CALL CENTER**

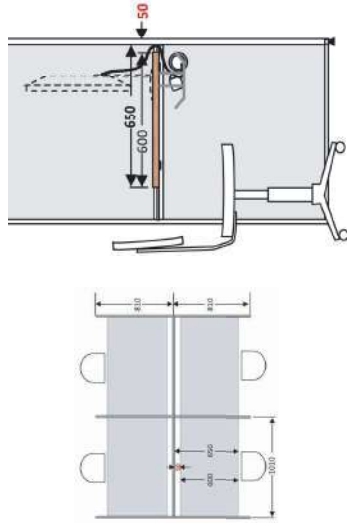
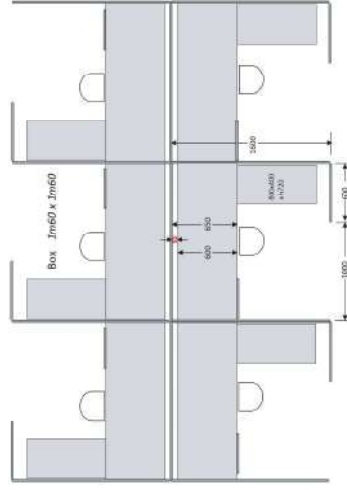

Rail aluminium pour fixation plateau
ou accessoires (voir page 40).
A intégrer dans la cloison.

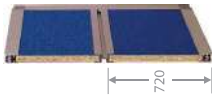

4 Supports pour plateau



Plateau mélaminé blanc ou gris
28mm + 4 supports MVH 110

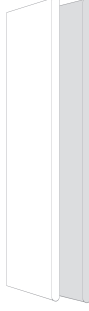

Aluminum profile for desk surfaces
or accessories (see page 40).
To be integrated into the screen.



4 Holders for desk surfaces



28mm thick white or grey
desk surface + 4 holders MVH 110

Alu-Profil für Tischplatten-Befestigung
oder Zubehör (siehe Seite 40).
In die Wand einlassen.

- Ref. MVH 100/ 610
- Ref. MVH 100/ 810
- Ref. MVH 100/ 1010
- Ref. MVH 100/ 1210
- Ref. MVH 100/ 1410
- Ref. MVH 100/ 1610
- Ref. MVH 100/ 1810

4 Halter für Tischplatte

Ref. MVH 110

28mm Melamin Tischplatte weiss
oder grau + 4 Halterungen MVH 110

- Ref. MVH 600 x 800
- Ref. MVH 600 x 1000
- Ref. MVH 600 x 1200
- Ref. MVH 600 x 1400
- Ref. MVH 600 x 1600

Kompakte Typ E Schreibstischsteckdose
mit USB-Ladefunktion 5V / 2,4A



Ref. MVH 213

E type compact desk power plug
with 5V / 2,4A USB charger



Prise compact type E
avec chargeur USB 5V / 2,4A



Kabelwanne 420mm lang under
Tischplatte zu befestigen

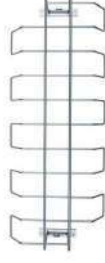

Ref. MVH 212

Cable support 420mm long to fix
under the desk surface



Goulotte pour câbles longueur
420mm à fixer sous le plateau

Kabelindurführung
(Bei Bestellung angeben)

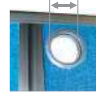

Cable pathway
(to be specified when ordered)

Ref. MVF 111

Passage pour câbles
(à prévoir à la commande)

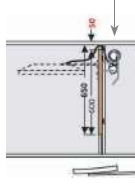



**REHAUSSE +
ÉCRAN EN VERRE**



**GLASS DESK
SCREEN + TOPPER**



**GLAS-
WÄNDE + AUFSATZ**



Rehausse en verre
trempé dépoli 5mm
5mm frosted tempered glass
(sécurité)
Aufsatz aus gehärtetem Mattglas
5mm stark (sécurité)

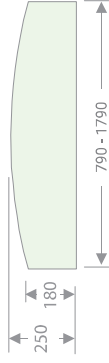

- Ref. MGD 250/ 790
- Ref. MGD 250/ 990
- Ref. MGD 250/ 1190
- Ref. MGD 250/ 1390
- Ref. MGD 250/ 1590
- Ref. MGD 250/ 1790



Clip pour verre
de 4 à 10mm avec écrou
Clip for 4 to 10mm glass
with nut
Klip für 4 bis 10mm starkes Glas
mit Mutter

Ref. MVU 002



Ref. MVM 280 → 10 - 28mm
Ref. MVM 380 → 20 - 38mm

Ecrans en verre
trempé dépoli 5mm
Glass desk screens
5mm frosted tempered glass
Glaswände
aus gehärtetem Mattglas 5mm stark

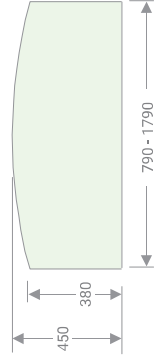

- Ref. MGD 450/ 790
- Ref. MGD 450/ 990
- Ref. MGD 450/ 1190
- Ref. MGD 450/ 1390
- Ref. MGD 450/ 1590
- Ref. MGD 450/ 1790

Pince bureau métallique
+ clip pour verre de 4 à 10mm
Metal desk clamp
+ clip for 4 to 10mm glass
Tischklammer
+ Klip für Glas von 4 bis 10mm

Ref. MVM 280
Ref. MVM 380





ACCESSOIRES



ACCESSORIES



ZUBEHÖR

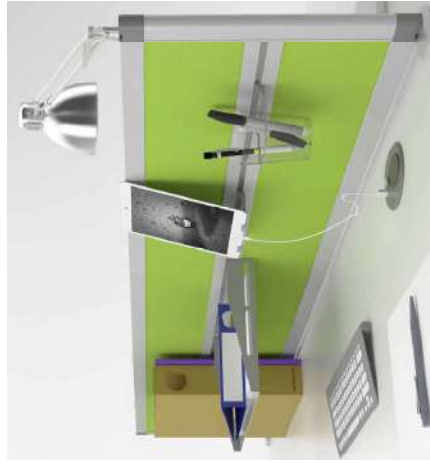

Rail aluminium pour accessoires sur les 2 faces de la cloison.
A prévoir à la fabrication.

Aluminium profile for accessories on both sides of the screen.
Must be specified prior to manufacture.

Alu-Profil für Zubehör an beiden Seiten der Trennwand.
Bei der Herstellung einzuplanen.

Plaque pour fixation accessoires 350 x H 330mm
A endlicher sur le profilé haut de la cloison.

Accessory plate 350 x H 330mm, interlocks on to the aluminium profile of the screen.

Platte zur Befestigung von Zubehör 350 x H 330mm, zum einrasten am oberen Profil der Trennwand.

Bac à Courrier 335 x 250 x 50mm

Paper tray 335 x 250 x 50mm

Ablagefach 335 x 250 x 50mm

Pot à crayon

Pen holder

Stift-Cup

Support tablette ou téléphone 80 x 60mm

Tablet or cell phone holder 80 x 60mm

Tablet- / Mobiltelefon-Halterung 80 x 60mm

Support inclinable et orientable pour écran LCD de 10 à 23" Peut être fixé directement sur la cloison avec vis traversantes ou sur la plaque Ref. MVH 200.

10-23" LCD monitor mount full rotation Can be fixed directly on the screen with screws through the panel or on the plate Ref. MVH 200.

Neig- und schwenkbare Halterung für 10-23" LCD-Monitor Kann direkt an der Wand mit durchgehenden Schrauben oder an der Platte Ref. MVH 200 befestigt werden.

Ref. MVH 100/ 610
Ref. MVH 100/ 810
Ref. MVH 100/ 1010
Ref. MVH 100/ 1210
Ref. MVH 100/ 1410
Ref. MVH 100/ 1610
Ref. MVH 100/ 1810

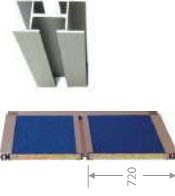

Ref. MVH 200



Ref. MVH 201



Ref. MVH 204



Ref. MVH 206



Ref. MVH 209



Crochet métallique

Metal hook

Metalhaken

Ref. MVD 200



Crochet porte manteau

Coatrack hook

Kleiderhaken



Profilé d'obturation en PVC souple gris

Shutterprofile flexible grey PVC

Verstopfprofile aus grau Weich-PVC



Ref. MVZ 001

Sabot à poser sur le bureau Prix unitaire

Base to place on the desk Unit price

Sockel auf den Tisch zu lege Stückpreis

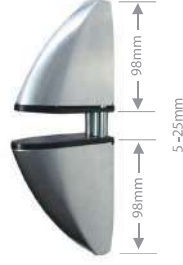

Ref. MVZ 200



**SOLUTIONS
ACOUSTIQUES**



**ACOUSTIC
SOLUTIONS**



**AKUSTISCHE
LÖSUNGEN**

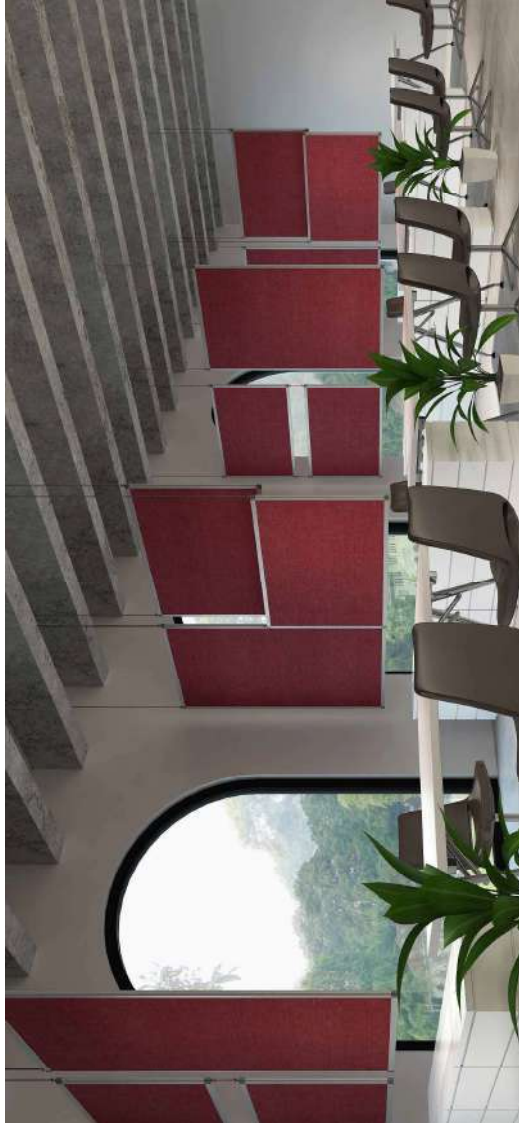

**Hauteur
Height
Höhe**

1000 mm

Ref. ATT 1000 x 600
Ref. ATT 1000 x 800
Ref. ATT 1000 x 1000
Ref. ATT 1000 x 1200
Ref. ATT 1000 x 1400
Ref. ATT 1000 x 1600



1200 mm

Ref. ATT 1200 x 600
Ref. ATT 1200 x 800
Ref. ATT 1200 x 1000
Ref. ATT 1200 x 1200
Ref. ATT 1200 x 1400
Ref. ATT 1200 x 1600



1400 mm

Ref. ATT 1400 x 600
Ref. ATT 1400 x 800
Ref. ATT 1400 x 1000
Ref. ATT 1400 x 1200
Ref. ATT 1400 x 1400
Ref. ATT 1400 x 1600



1600 mm

**Hänge- und wandpaneele
Super-Akustik
Akustikteste Seite 17**

**Hanging and wall panels
Super-Acoustic
Acoustic tests page 17**

**Panneaux suspendus et muraux
Super-Acoustique
Tests acoustiques page 17**

**Fixation pour panneaux suspendus
câbles longueur réglable
(maximum 2 m) vendus par deux**



**Vertical
1 x APD**

**Fixing for hanging panels
Adjustable length cables
(maximum 2 m) sold by two**



**Horizontal
2 x APD**

**Befestigung für Hängepaneele
Kabel mit einstellbarer Länge
(maximal 2 m) zu zweit verkauft**

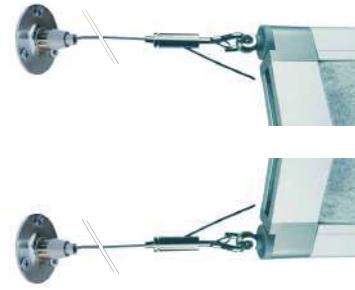

Ref. APD

Fixation pour panneaux muraux



Fixing for wall panels



Befestigung für Wandpaneele



Ref. APM



CLOISONS MOBILES À ANGLE DROIT



FREESTANDING ANGLE PARTITIONS



BEWEGLICHE ECKTRENNWÄNDE



Les panneaux mobiles à angle droit se rangent facilement dans un coin.
The angle partitions can easily be stored in a room corner.
Die bewegliche Trennwände können einfach in einer Ecke eingestellt werden.



Les Cloisons Reyem à angle droit sur 3 roulettes permettent de séparer rapidement vos espaces, peuvent être utilisées dans des salles polyvalentes, musées, expositions...

✓ BONNE STABILITE

✓ FACILE A DEPLACER ET A ASSEMBLER

✓ GAIN DE PLACE LORS DU RANGEMENT

Ensemble de deux cloisons
+ kit 3 roulettes
Mélaminé blanc de 8 mm

Pour d'autres coloris ou PVC blanc de 8 mm classé feu M1 / B, S3, do veuillez nous consulter.

The three-castor free-standing partitions by Reyem are a fast and easy solution to separate your spaces. They can be used in function rooms, museums, exhibitions and many other locations...

✓ A STABLE SOLUTION

✓ EASY TO TRANSPORT AND ASSEMBLE

✓ SAVE VALUABLE STORAGE SPACE

Two partitions
+ 3 castor kit
8mm white melamine

For other colours, or 8mm white PVC with fire safety classification B, S3, do, please contact us.

Die rechtwinkligen Trennwände auf 3 Rollen ermöglichen Ihnen eine schnelle Raumteilung und können in Mehrzweckhallen, Museen, Ausstellungsräumen usw. eingesetzt werden.

✓ GUTE STABILITÄT

✓ EINFACH BEWEGBAR & ZUSAMMENBAUBAR

✓ PLATZSPAREND VERSTAUBAR

Einheit aus zwei Trennwänden
+ 3 Rollen satz
8 mm weiß Melamin

Für andere Farbe, oder 8 mm Weiß PVC, Feuersicherung Class B, S3, do, kontaktieren Sie uns.

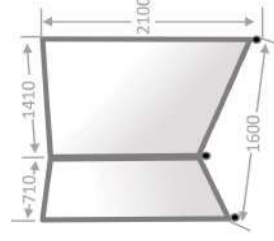

Ref. PAS 2100 1410 / 710



Crochet métallique
Metal hook
Metalhaken

Ref. MVD 200



Kit 3 roulettes uniquement
3 castor kit only
Einzel 3 Rollensatz

Ref. EP 57



Roulettes avec frein
Locking castors
Rollen mit Bremsfunktion